

EN

PEAK⁶ USER MANUAL

Version: 11-2024

FLYSURFER

CONTENT

01	Release of Liability	4
02	Safety Notes	5
02.01	Do not fly with kites	5
03	Overview of the Kite	6
04	Handling	8
04.01	Setting up a single-skin kite	8
04.02	Connecting a PEAK with Line Connectors	9
04.03	Sorting the bridle	9
04.04	Securing the single-skin kite	9
05	Launching	10
05.01	Self launching a foil kite at the edge of the wind window	10
05.02	Edge of the wind window with a helper on a foil kite	10
06	Relaunch	11
06.01	Reverse relaunch	11
06.02	Drainage	11
07	Landing	12
07.01	Landing with an assistant	12
07.02	Landing using the B-Safe System	12
07.03	Landing using the Frontline Safety	13
08	Safety Systems	13
08.01	Frontline Safety (FLS)	13
08.02	B-Safe System (5th line)	13
08.03	Reactivating the kite	14
09	Emergencies	14
10	Self-Rescue	14
11	Packing Up	15
12	Kite Care	16
13	Assembly of the B-Safe System	16
13.01	Assembling the B-Safe Main Lines on the PEAK ⁶	16
13.02	Converting the CONNECT ³ Control Bar from FLS to B-Safe System	17
13.03	Extending the B-Safe Line	18
13.04	Shortening the Flying Lines with the B-Safe System	18
14	Maintenance	19
14.01	Replacing the Sparepart Lines and Pulleys	19
14.02	Little Connection Lines.....	20
14.03	Repairing the cloth	21
15	Trimming	21
15.01	Performance Tuner	21
15.02	Optimum trim of the Flying Lines	21
16	Repair & Spare Parts	21

01 RELEASE OF LIABILITY

Release of liability, claim waiver, assumption of risk

By assembling and/or using this FLYSURFER product, you agree that you have read and understood the entire FLYSURFER product manual, including all instructions and warnings contained in that user manual, prior to using the FLYSURFER product in any way. You additionally agree that you will ensure any additional or subsequent user of your FLYSURFER product will read and understand the entire FLYSURFER product user manual, including all instructions and warnings contained in that user manual, prior to allowing that person to use your FLYSURFER product.

Assumption of Risk

FLYSURFER product and any of its components involve certain risks, dangers, and hazards that can result in serious personal injury and death to both the user and to non-user third parties. In using this FLYSURFER product, you freely agree to assume and accept any and all known and unknown risks of injury and you and third parties while using this equipment. The risks inherent in this sport can be greatly reduced by abiding by the warning guidelines listed in this user manual and by using common sense.

Claim Waiver

Release and waiver of claims in consideration of the sale of the FLYSURFER product to you, you hereby agree to the fullest extent permitted by law, as follows:

To waive any and all claims, that you have or may in the future have against Skywalk GmbH & Co. KG and all related parties resulting from use of the FLYSURFER Product and any of its components. To release Skywalk GmbH & Co. KG and all related parties from any and all liability for any loss, damage, injury or expense that you or any users of your FLYSURFER product may suffer, or that your next of kin may suffer, as a result of the use of the FLYSURFER product, due to any cause whatsoever, including negligence or breach of contract on the part of Skywalk GmbH & Co. KG and all related parties in the design or manufacture of the FLYSURFER product and any of its components. In the event of your death or incapacity, all provisions contained herein shall be effective and binding upon your heirs, next of kin, executors, administrators, assigns, and representatives. Skywalk GmbH & Co. KG-related parties have not made and expressly deny any oral or written representations other than what is set forth herein and the FLYSURFER User's Manual.

If you have any questions (repair, replacement parts installation, tuning, etc.) the dealers you trust get faster help and correspondingly cheaper support (e.g. by saving shipping costs).

You can find all dealers in your area via our partner map:

<https://flysurfer.com/fs-partner/>

If you need further help, you can reach us at headquarters by phone or email.

Email: support@flysurfer.com

Phone: +49 (0) 8641 6948 0

02 SAFETY NOTES

Read the entire online user manual thoroughly before using the product, and strictly confirm to the procedures noted. **The following safety guidelines are only suggestions and do not claim to cover every instance.**

01. Kitesurfing is a **potentially dangerous sport**, that holds risks for the athlete or the people surrounding them. Incorrect use of this product may result in **serious injury or even death** for the user or third parties. Every user should be qualified by a FLYSURFER kiteschool or a FLYSURFER dealer.
02. The user carries the **sole responsibility** for themselves and third parties when using this product. The user must check their equipment for wear, especially wearing parts, before each kite session. Do a test activation of your quick release before every launch. This will ensure the system is working and reinforces the release instinct of the kiter.
03. The product may only be used with **original spare parts**, and may not be modified.
04. This product has been designed for riders weighing 40-120kg. We cannot guarantee the proper functioning of the product outside of this weight range.
05. Never kite in unsuitable conditions such as storm fronts, lightning, or offshore winds. Check the weather and wind conditions carefully and choose the appropriate kite size.
06. Check out the kiting spot beforehand. Make sure you are aware of any risks and dangers such as obstacles, shallows, currents and bans. Also be aware if a rescue craft can get to you in case of an emergency. It is always best to ask people (locals) who know the area well.
07. Keep a safety margin of at least two line-lengths downwind of you, and never kite near people or obstacles. Kiting near powerlines, roads, airports, cliffs, etc. is extremely dangerous.
08. Make sure that someone is looking out for you and that help is available if you need it. Never go out alone. Never kite further away from shore than you can swim back.
09. The incorrect usage of lines creates a high risk of injury for yourself as well as others. Body parts that get caught in the lines of the kite may suffer from severe injury or burns.
10. Only use bars with a safety system that you can open in emergency situations. Use a quick-release kite leash so that you can disconnect your body from the product in case of an unforeseeable emergency.

02.01 Do not use kites for flying

A kite is not designed, tested or licensed as an aircraft or flying device. The use of a kite as a flying device is illegal and not covered by insurance. **Flying with this product can lead to death!**

03 OVERVIEW OF THE KITE

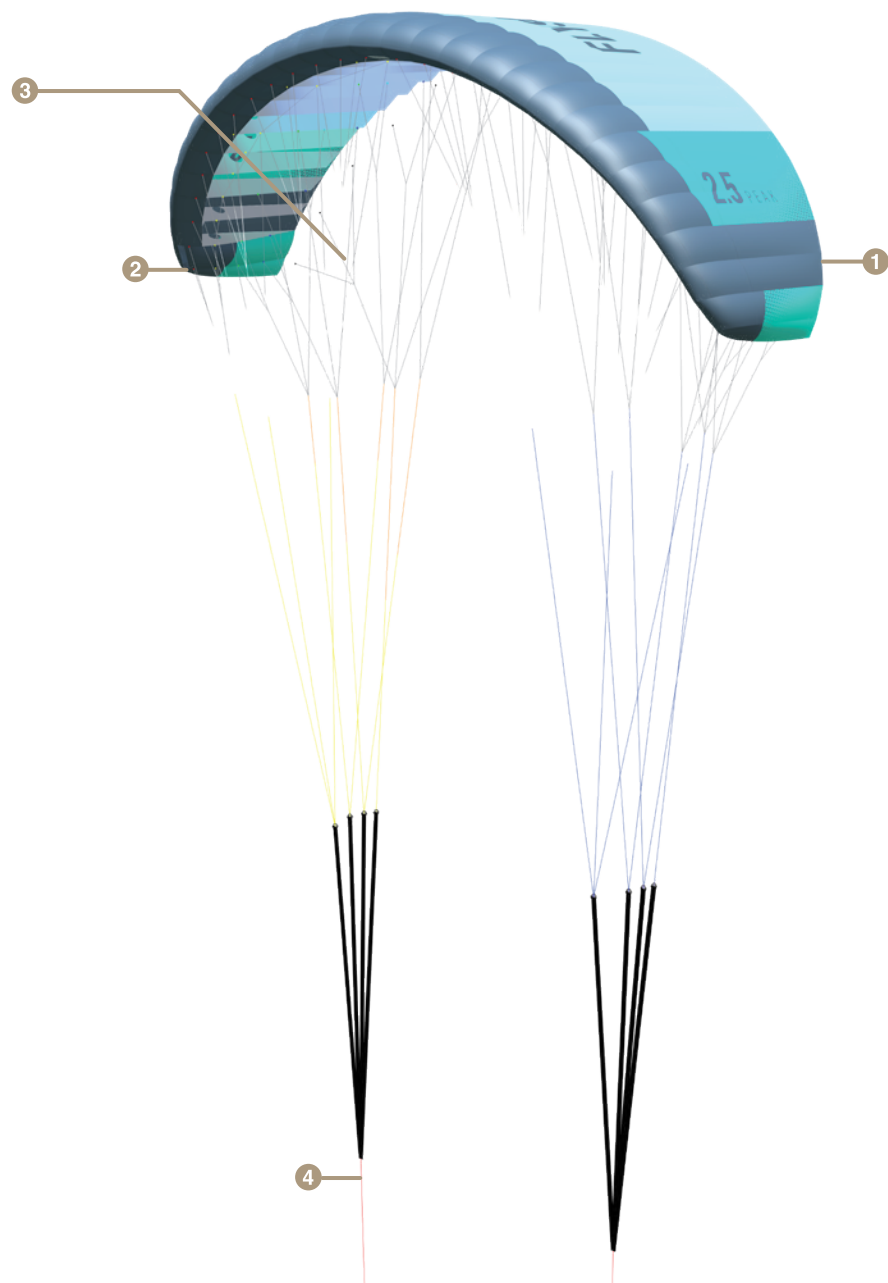

1 TX-Light Single Skin Concept

The single skin concept is characterized by high-lift profiles, high safety reserves, and efficient depower. The reduced weight offers advantages to stability, drift, and light wind handling. Single skins also enable the use of convenient safety systems and reliably absorb hard impacts. The excellent durability comes with carefully selected materials and construction.

2 Hybrid Wingtip Technology

The hybrid wingtip technology is protected with nets that prevent snow and dirt from entering the self-inflating cells. It improves the airflow and enables tight, constant loops with high backstall resistance. The single-skin kite only flutters when depowering, which optimizes the bar feedback and offers a sporty, confidence-inspiring ride.

3 B-Safe System

The B-Safe system uses a line configuration that runs through eyelets along the B-Level. When the quick release is activated, the CONNECT³ Control Bar rises 4m on the 5th line, gathering the kite in the middle and minimizing the wing area. The kite sinks gently and blows out without any power. After re-engaging the quick release, the kite can be relaunched through the power zone. The B-Safe System is ideal for self-landing and is reliable in emergencies.

4 Performance Tuner

The Performance Tuner, integrated into the C-Pulley Line, adjusts the camber of the kite. By moving the Z-Main Line, bar forces and performance can be influenced: shortening increases low end, steering and holding forces; lengthening reduces backstall, steering and holding forces.

04 HANDLING



A kite must be securely secured even in light winds, as an unsecured kite can endanger people lying downwind. To protect the material, we also recommend not leaving the kite in the wind and sun for an unnecessarily long time.

04.01 Setting up a single-skin kite

1 Unroll the kite upside down towards windward and secure it to the front edge with a weight (e.g., a sandbag) appropriate for the wind strength and not sharp.

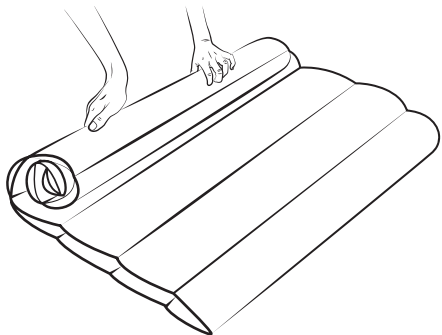

2 Place the bar far away from the trailing edge so it cannot get caught by the bridle lines.

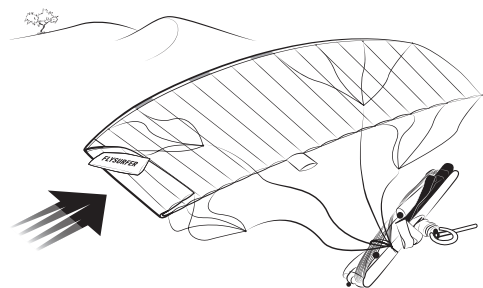

3 Open the kite. Unwind the flying lines as you move away from the kite.

4 Check your bridle for tangles. Make sure that none of the lines are caught around the back of the kite.

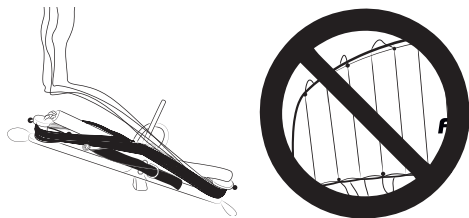

5 Start at the leading edge holding up the front lines to visually check the bridle step by step.

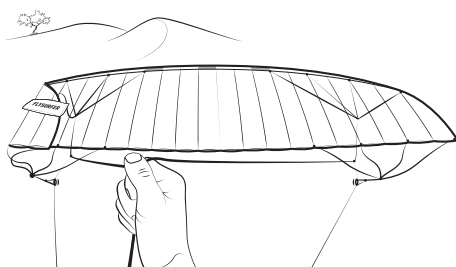

6 When the bridle is sorted, put the front lines to the inside and the steering lines to the outside. If not, follow the tips in the chapter "Sorting the bridle".

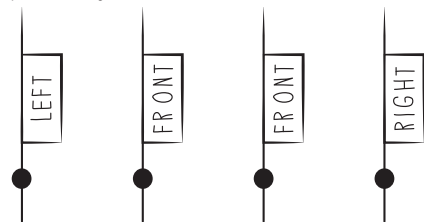

7 Sort the flying lines. Check them for damage and knots.

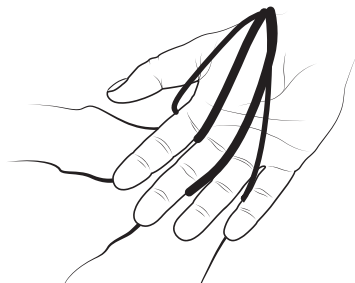

04.02 Connecting a PEAK with Line Connectors

Line Connectors are designed to protect the flying line ends for kites who frequently connect and disconnect their control bar or use one control bar for multiple kites. We recommend leaving the Line Connectors (pigtails) off if the control bar remains attached to the kite.



1 Soften the lines before first use and tie a lark's head knot a few times.

2 Connect the front and back lines to the PEAK's front main and back main lines with a bow knot.



Note: Always ensure that once the Line Connectors are connected to the kite, they are fully tightened by abrupt pulls.

04.03 Sorting the bridle

Even a heavily knotted bridle can be sorted out again with the correct technique.

1 Roll up your flying lines and secure them with a half hitch and/or a bungee cord.

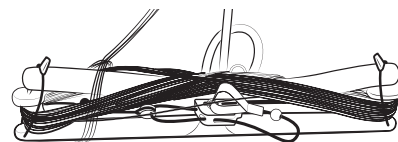

2 Undo any loops, knots, or bunches that may have formed by pulling the lines apart and loosening them.



3 Lift the A-Level and lightly tension up the bridle again to check it. Repeat the process with the B and C-planes. If necessary, put the control bar through the bridle.

4 Finally, check the Z-Level.

5 Treat the left and right sides of the bridle separately.

Note: If the bridle cannot be sorted, it helps to separate the control bar from the kite and repeat the process. The mixer is put through the bridle instead of the control bar to free it.

04.04 Securing the single-skin kite

1 Fold the kite in the middle and let the wingtips blow out to leeward. The bridle is on the inside. Place an object in the front third of the top sail. This prevents the wingtips from flapping in the wind.

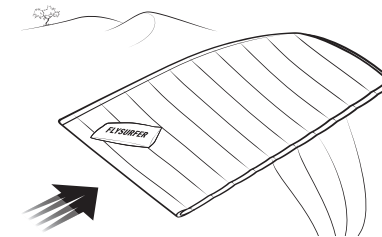

Tip: The kite can also be secured to a wingtip when launching. However, the kite can flap in the wind, and the bridle can become knotted.

2 Make sure that the wingtips do not flap in the wind. You can also secure them with a little sand or a suitable object.

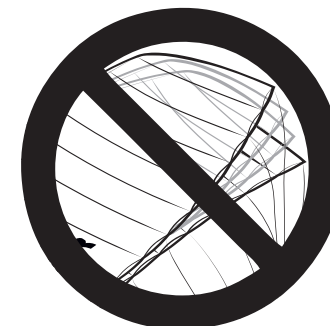

05 LAUNCHING

Please check not only the wind and weather conditions but also all your equipment, especially the safety system, before launching. Do not use any kite outside of its recommended upper wind range. When launching in strong winds, we recommend that you have an assistant hold you from the back of your harness. During launching, always pay attention to ensure that your bridle lines do not get caught on anything or become tangled.

05.01 Self launching a foil kite at the edge of the wind window

- 1 Lay the kite out with the wind. Fold the windward wingtip over and put weight on the leading edge.

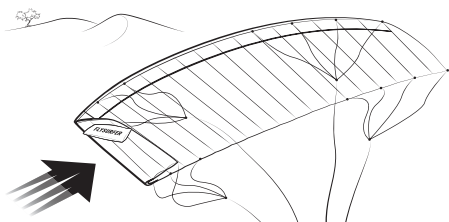

- 2 Position the kite at about 15-30 degrees to leeward and carefully put tension on the lines.

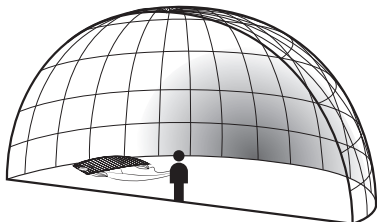

- 3 Move to leeward little by little to tighten the lines. Make sure that the leeward tip does not tip over to windward.



- 4 Release the weight from the wingtip by taking a step backward and gradually steering it upwards.

Tip: You can prevent the lines from tipping over on the wingtip by folding the wingtip over again after weighing it and adding a little weight.

05.02 Edge of the wind window with a helper on a foil kite

When launching with a helper, the helper must be instructed and practiced.

- 1 Position the kite and helper at the edge of the wind window. Make sure that all lines run freely.

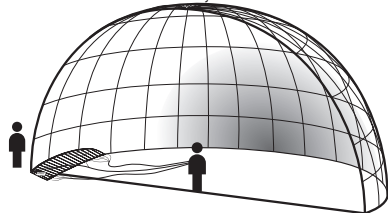

- 2 The assistant begins from the center of the kite with the leading edge (LE) into the wind. As the kite shapes its form, the assistant slowly works his hands down the leading edge until the kite is fully opened and lets the kite rise up

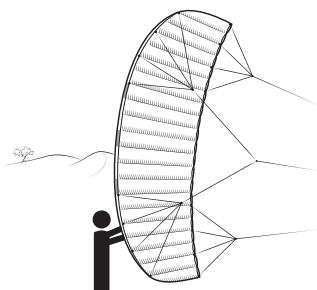

- 3 Give the helper the thumbs-up signal that he can let go.

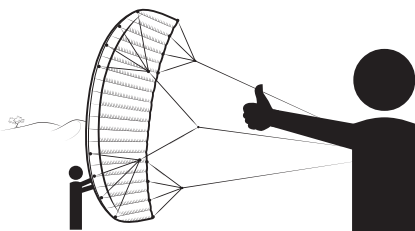

Note: Get aligned with the wind, the helper retains his position and is not moving around.



06 RELAUNCH

06.01 Reverse relaunch

- 1 Grab the leader lines above the floaters. Ensure the control bar's light side (orange/grey/beige) is still on the left. This way, the control bar will be the right way around after the relaunch.

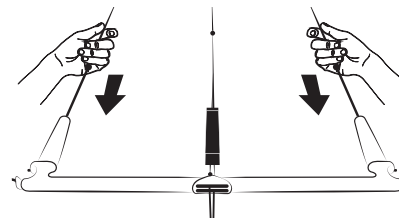

- 2 Pull both leader lines far back. The kite will release backward from the surface. If the kite does not release, grab the leader lines further up.

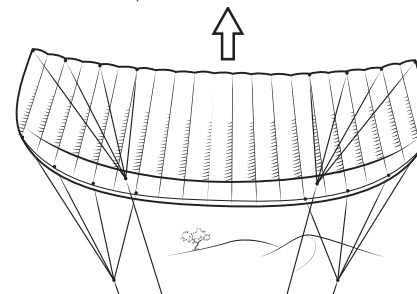

- 3 When the kite has risen by at least one span, let go of one leader line.

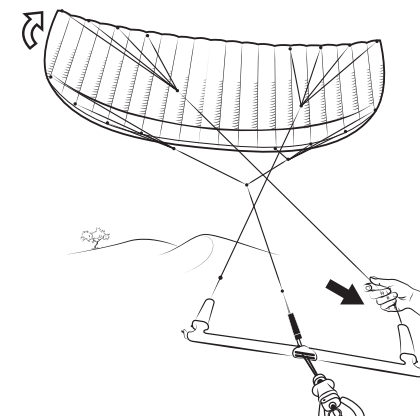

- 4 The kite will now turn. As soon as the leading edge points upwards again, let go of the pulled leader line and control the kite with the control bar.

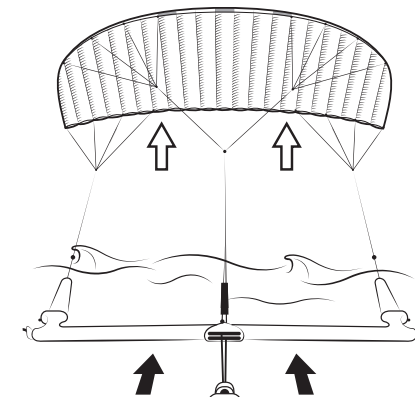

Tip: The reverse relaunch is the recommended relaunch option when kiting on land. This protects the kite's materials and increases its lifespan.

06.02 Drainage

The drainage system ensures that small objects can be removed from the closed cells of the wingtips. The wingtip must be held on one side, and the objects slide through a cut on the trailing edge.

07 LANDING

07.01 Landing with an assistant

- 1 The safest and easiest way is to land with a trained assistant. Signal your intention to land. The assistant should be upwind of the kite.

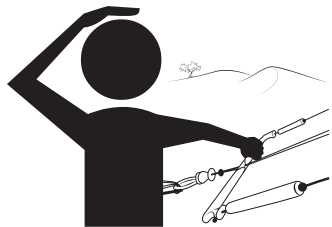

- 2 Lower the kite towards the helper along the edge of the wind window.

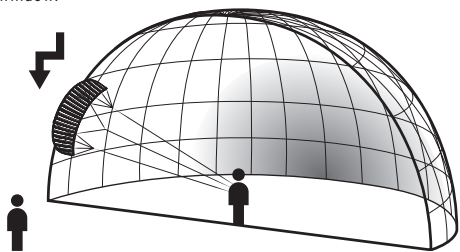

- 3 The helper can now approach the kite and grab hold of the leading edge of the kite.

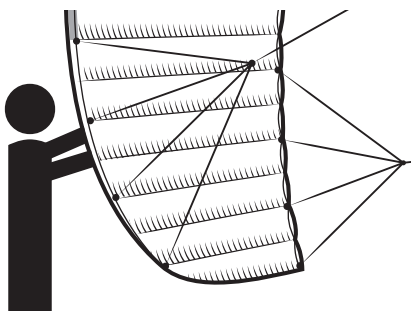

!!! Warning: The helper should never grab any lines.

- 4 Secure the kite as described in "Securing the Kite".

07.02 Landing using the B-Safe System



Warning: When landing without help, ensure a safety distance of at least two line lengths to the next object. In unfamiliar terrain or poor visibility, we recommend pulling the kite to you using the flying lines!

- 1 Grab the B-Safe end line and pull it towards you to reduce the PEAK's span. Alternatively, the quick-release system can release the PEAK for landing.

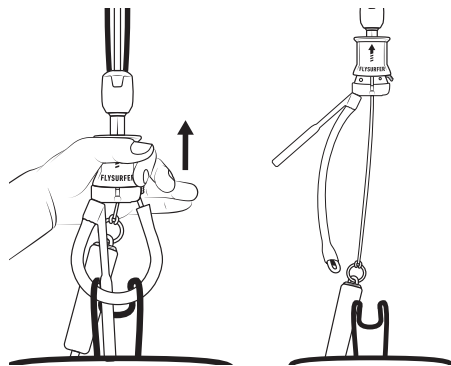

- 2 Pull the B-Safe end line back so far that the wingspan reduces, and the kite flies backward to the ground and remains lying there.

- 3 Secure the B-Safe end line to a suitable object. Ice axes, ski or snowboard bindings, pegs, or other aids can be used for this.

- 4 Secure the kite as described in the "Securing" section or pack it in the bag if necessary.

Tip: In deep snow, leaving the skis or snowboard strapped on is advisable.

07.03 Landing using the Frontline Safety

- 1 Ensure the landing area is large and free of objects that could damage the kite. Fly the kite to the wind window side where the Frontline Safety is attached, at the edge of the wind window. Activate the quick release.

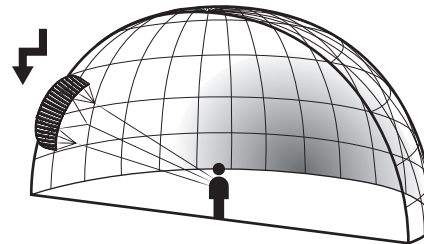

- 2 The kite will now flag out on the Frontline Safety and rest downwind.

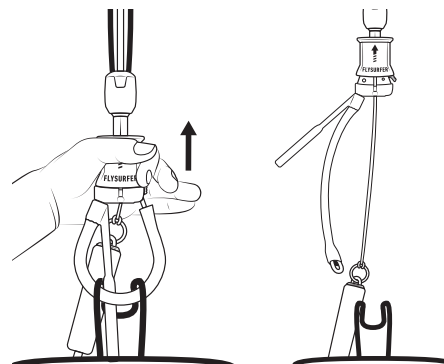

- 3 Attach the safety leash to a suitable object. Ice axes, ski or snowboard bindings, pegs, or other aids can be used for this.

- 4 Secure the kite as described in the "Securing" section.

08 SAFETY SYSTEMS

08.01 Frontline Safety (FLS)

- 1 The PEAK® kites can be equipped with a Frontline Safety (FLS). We recommend using FLYSURFER Control Bars to guarantee the function of the Frontline Safety system.

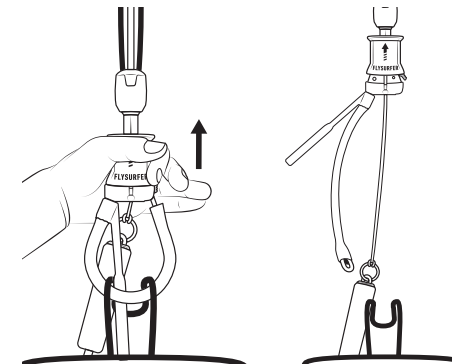

- 2 After triggering the Quick Release, the Control Bar will slide up to the stopper ball / knot. The kite will flag out on this single front line.

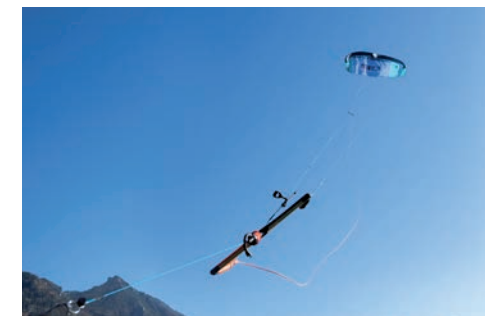

08.02 B-Safe System (5th line)

All PEAK® kites can be equipped with the B-Safe System. The lines required for this are included in the delivery. We recommend our CONNECT3 Control Bar to ensure the full functionality of the B-Safe System.

- 1 After activating the quick release, the control bar moves along the B-Safe Line towards the kite.

- 2 The PEAK is gathered together and falls from the sky without power.

Tip: This method is suitable for self-landing. Using the B-Safe System offers the highest level of safety!

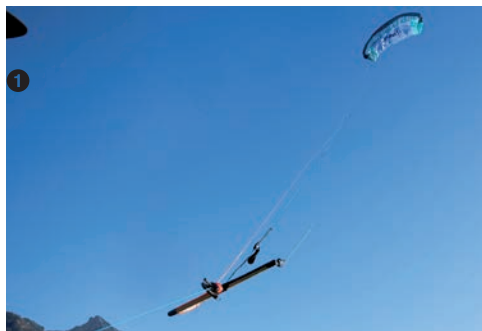

08.03 Reactivating the kite

After releasing the kite, you can restart it by engaging the release lever (quick release). We recommend reading our Bar Safety Guide in detail!

- 1 Secure the safety end line to the harness hook and hang on to it until you reach the control bar. Now, you can reassemble the quick release with both hands.

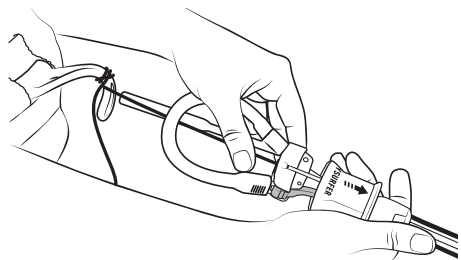

- 2 Hook the chicken loop with the chicken stick into the harness hook and gradually release the end line.



Warning: Ensure that no lines wrap around any parts of your body. To avoid burns and cuts, do not let the end line slide through your fingers too quickly.

Tip: If the kite gets caught after release and cannot be started, it can help to release it.

09 EMERGENCIES

In an emergency situation it is important not to panic, and to react purposefully and goal-orientated.



Especially in very gusty conditions the **kite can overfly its pilot**. This can be corrected by powering up the kite by pulling the bar towards you or pulling in the leader lines (red and green). It is also possible to counter the kite's overflying, or get it back into the wind window by flying it back and forth.



Should the center of the kite collapse towards the pilot (e.g. frontstall) it is important to activate the quick release before it opens again, as the kite can develop a lot of power when it opens again in the wind-window.

10 SELF-RESCUE

- 1 Activate the quick release.

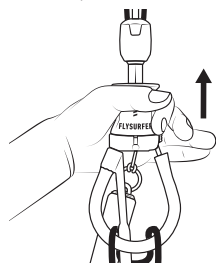

- 2 Work your way up the safety endline to the control bar. Wind the loose endline round the bottom of the bar in a figure of 8.

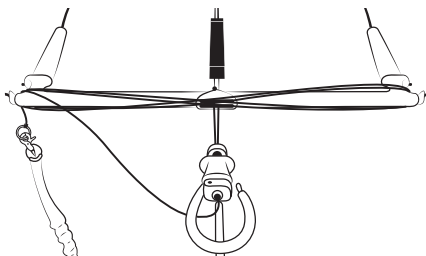

- 3 Now roll the flying lines onto the bar and secure them with the bungees or even better using a half hitch.

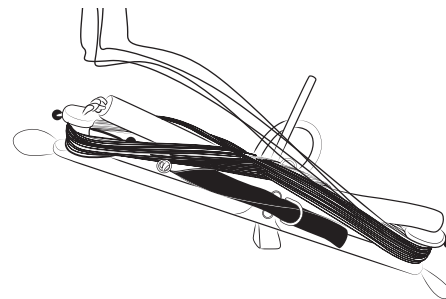

- 4 Grab the kite.

- 5 Lay the tips on top of each other, and then the control bar on top and roll up the kite. Be careful with the bridle lines and stow them as best you can within the two halves of the kite when rolling it up.

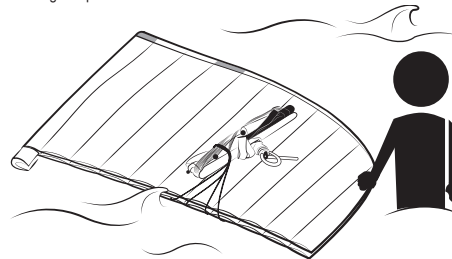

- 6 Secure the kite in a bag or with a strap.

11 PACKING UP

A FLYSURFER kite can be easily stowed in the bag. It is essential that the bridle is stowed in the kite and that the control bar does not get caught in or between the bridle lines.

- 1 Wrap up the control bar until just before the mixer and secure the lines with the rubber bands or a half hitch. Place them far enough away from all the bridle lines.

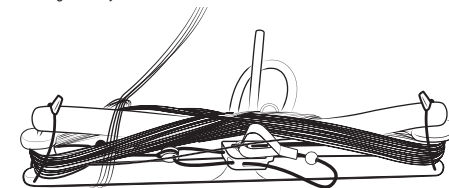

- 2 Fold the kite in the middle and ensure no bridle lines are running around the outside of the kite.

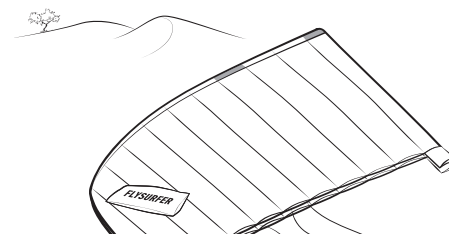

Tip: If you do not want to wrap the possibly wet control bar in the kite, attach it to the outside of the bag. First, fold the kite in the middle, roll it up with the bridle, and stow it in the bag.

- 3 Stow the control bar separately. Place it on the top sail at some distance from the two wing tips.

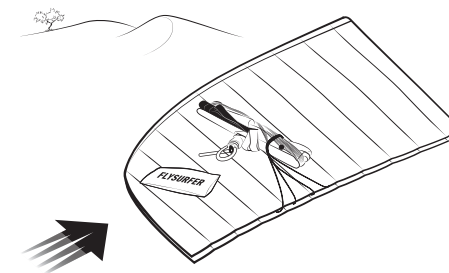

- 4 Stow all the bridle lines between the two halves of the folded kite.

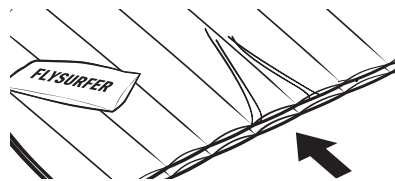

- 5 Roll up the kite around the control bar. Make sure that no sharp objects can damage the fabric.

- 6 Fold the kite around the control bar on both sides and stow it in the bag.

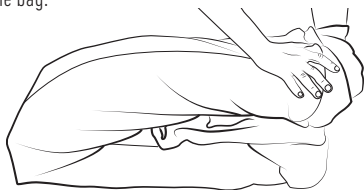

12 KITE CARE

FLYSURFER kites are very durable and very UV and saltwater resistant. With proper care, your kite may last even longer. Eventual color changes of the cloth can be caused by environmental causes, UV-exposure, mechanical strain as well as it getting dirty. A color change has no influence on the flight characteristics whatsoever and is not covered by warranty.

Do not leave the kite exposed to the elements.

People who pack away their kite right after a session, or for a longer break, will minimise the amount of time the material is exposed to the sun and flapping in the wind, extending the "active" lifespan of their kite.

Drying

If a kite is packed away wet and left for a long period of time it can develop ugly mildew spots, rust on the metal parts or color bleeding of the cloth. This does not affect how the kite performs, but will reduce the value of your kite. In extreme cases the kite may get mouldy. To dry, simply continue to fly the kite until the canopy is dry.

Check

Check all parts of the kite before each use. Especially parts that can wear out. Material failure on those parts can lead to further damages, or put the kiter at risk.

13 MONTAGE B-SAFE SYSTEM

Note: Only the FLYSURFER CONNECT Control Bar has the B-Safe System! The safety feature cannot be activated with other control bars!

13.01 Assembling the B-Safe Main Lines on the PEAK⁶

- 1 Take the grey B-Safe Main Line out of the PEAK Bag and unwind it from the box.



- 2 Take the A-level of the PEAK and place it behind the leading edge and away from the kite.

- 3 Look for the red LCL (Little Connection Lines) above the B-level as described in the line plan.

- 4 Make sure that the B-Safe Main Line of the PEAK is correctly positioned between the A and B levels and is attached to the red LCLs with a bow knot.



13.02 Converting the CONNECT³ Control Bar from FLS to B-Safe System

The CONNECT³ Control Bar is delivered as a 4-line system with FLS (Frontline Safety System). Remove the B-Safe Line set from the CONNECT³ Bar Bag.



- 1 Unwind the flying lines to the front connector line (Y-split) and sort the back and front lines.



- 2 Disconnect the line connector from the black front line and connect it to the blue safety line.



- 3 Pull the black front line through the metal ring and disconnect it from the blue safety line.



- 4 Loop the black line connector back onto the black front line.



- 5 Loop the black front line above the metal ring into the loop of the front connector line (Y-split). The metal ring must sit below the looped front line.



- 6 Unwind the blue B-Safe Line from the cardboard.

- 7 Connect the blue B-Safe Line to the blue safety line.



- 8 Pull the blue B-Safe Line through the metal ring of the front connector line (Y-split).



- 9 Tie the blue B-Safe Line with a bow knot to the small knot in the middle of the grey B-Safe Main Line of the PEAK.



13.03 Extending the B-Safe Line

Note! The B-Safe Line length can be adjusted after heavy use. A B-Safe Line that is too tight will affect the PEAK's flight behavior!

- 1 Find the overlapping section with two knots.



- 2 Open both bow knots and slide them over the knots.



- 3 Pull them tight to extend the B-Safe Line.



13.04 Shortening the flying lines with the B-Safe System

The B-Safe System is fully functional even with 14 m flying lines.

- 1 Unwind the flying lines and sort the back and front lines.
- 2 Disconnect the connection between the B-Safe Top Lines (PEAK) and the B-Safe Line.
- 3 Take either a back or front line.
- 4 Disconnect the 7 m extension line from the flying line (back or front line).



- 5 Push the extension line through the loop to open it. The B-Safe Line does not have a line connector attached.



- 6 Unloop the extension line and repeat the process on the remaining three flying lines.

- 7 Connect all four connector lines to the appropriate back and front lines.



- 8 Connect the B-Safe Line and all flying lines to the PEAK.

14 MAINTENANCE

The main wearing parts of the kite are the depower line, the safety end line (see the control bar operating instructions) and the spare part lines and rollers. Depending on the use, flying lines or other components may also need to be maintained over the course of your kite's lifespan. Failure to maintain the kite can result in damage and will void the warranty.

14.01 Replacing the Sparepart Lines and Pulleys

The Sparepart Lines are the yellow lines that run through the pulley system known as the mixer. The Sparepart Line should be replaced before the sleeving could tear or fray (approx. 100 h). The pulleys should be changed after about 250 hours of use.

Tip: Always exchange only one side at a time and use the other side as a template of how the mixer should look like.

- 1 Lay out the kite and sort out the bridle. Ensure that the lines are not crossed or mixed up throughout the procedure.



- 2 Disconnect the front and steering lines on one side. Undo the front- and back main lines at the mixer. Pull the old Sparepart Lines out of the pulley. Always exchange both lines. (after approx. 100 h)



Caution: When replacing a pulley (after approx. 250 hours), focus is needed. Scan the QR code to get to the tutorial.

- 3 Open the lark's head knot that sits on the knot above the pulley on the C-Main. Pass the pulley through the loop.



- 4 Replace the pulley and feed the line through the new pulley. Form a lark's head knot.



- 5 Pass the pulley through the loop.



- 6 Slip the loop over the knot and tighten the lark's head knot.



- 7 Loosen the connection between the orange and gray lines and the black B-Main. Slide the loosened thin lines toward the pulley. Pass the pulley through the loop of the black B-Main. The pulley is now free.



- 8 Detach the black B-Main Line from the pulley. Replace the pulley. Pass the black B-Main Line through the pulley hole from both sides.



9 Widen both spliced loops at the lines ends. Slip one end of the line over one finger. Place the large loop over it. Take the second end of the line and put it over the finger as well.



10 Take the orange bridle line first, then the grey bridle line, and pull them both up to the middle of the black B-Main. Feed the pulley through all the loops of the black B-Main. Ensure you do it in the correct order!



11 Sort the black B-Main and pull the orange and grey lines tight. Both lines must be tightened properly.



12 Take the grey B-Pulley Line and feed it through the pulley. Form a lark's head knot and slip it over the C-Pulley. Tighten the lark's head knot below the knot on the black C-Pulley Line.



13 Take the grey C-Pulley Line with the knot ladder and lead it through the C-Pulley.



14 Take the orange Z-Main and connect it with a lark's head knot below the middle knot on the C-Pulley Line.



15 Reconnect the orange Back-Main to the end of the C-Pulley Line. Loop the Front-Main in the correct order as shown in the picture.



Tighten all connections and repeat the process on the other side. We recommend always replacing spare parts on both sides.



Note: After replacing the Pulley Lines, do the bridle check.

14.02 Little Connection Lines

The "Little Connection Line" (LCL) allows you to quickly exchange a bridle line and also works as a predetermined overload weak point that prevents the canopy from getting damaged. Should an LCL break, replace it with new one, in the same colour (same breaking strength) LCL.



14.03 Repairing the Cloth

In case you get a small tear (e.g., through contact with a sharp object) we have included a repair kit with your kite. The area that needs to be repaired must be clean, dry, and grease-free. Temporary repairs are possible with spinnaker repair tape, but the tear should be taped from the inside of the kite. It is recommended that you round off the edges of the repair tape. A special binding agent (silicone sealing compound) for the X-Light Cloth is available through Flysurfer sales partners or directly at FLYSURFER. A repair manual is included with the binding agent. We can possibly have a professional repair done. We can exchange whole parts of the canopy so that there will be no trace of the damage.

Tip: When a tear is close to a seam (less than 5cm), we recommend using sewing to repair the damaged area.

15 TRIMMING

As all lines change length over time, we have built in a way to correct the flying characteristics quickly and easily. Adjustments after heavy use over years should be done to keep the products performance and ensure a long-term use of the HYBRID.

15.01 Performance Tuner

The performance tuner is a knot ladder integrated into the C-Pulley Line to modify the camber of the kite. Move the Z-Main Line on the knot ladder to affect performance and control bar forces.



1 By default, the line sits below the center knot. This trim variant offers balanced control bar forces as well as performance and stability.



2 Moving the Z-Main Line on the knot ladder towards the kite: Lengthening the line softens control bar forces and reduces backstall. This trim variant allows the kite to fly further toward the edge of the wind window. We recommend it in the upper wind range.



3 Moving the Z-Main Line at the knot ladder towards the control bar: Shortening the line increases control bar forces and the kite is more cambered. This trim variant allows the brakes to engage earlier and improves the responsiveness of the kite. We recommend them in combination with twin tips or for wave riding.



15.02 Optimum trim of the flying lines

Steering (back) lines shorten over time in relation to the flying (front) lines. Underneath the floaters, the back line can be shortened or extended by using knots. Extension of the back lines is necessary when the trimmer needs to be pulled in too much to keep the kite flying normally in its intended wind range. (back-stall tendency).

16 REPAIR & SPARE PARTS

Repairs can be done at either our workshop in the head office, or by a Flysurfer sales partner who offers a repair service. High quality original spare parts for all our Flysurfer products can be ordered directly from our Online-Shop: shop.flysurfer.com

FLYSURFER

FLYSURFER
Brand of Skywalk GmbH & Co. KG
Windeckstr. 4
83250 Marquartstein, GERMANY

For further information please visit: www.flysurfer.com